

## 7 CH Power Management IC

### General Description

The RT9971 is a complete power supply solution for digital still cameras and other hand held devices. The RT9971 is a multi-channel power management IC including two step-up DC/DC converters, two step-down DC/DC converters, one selectable step-up/step-down DC/DC converter, one inverting DC/DC converter and one WLED driver.

The RT9971 is designed to fulfill the applications for DSC just as follows :

CH1 is a synchronous step-up output for motor or DSC system I/O power

CH2 is a selectable synchronous step-up/step-down output for motor or DSC system I/O power

CH3 and CH4 are synchronous step-down outputs for DSP core and memory power supply

CH5 is a high voltage step-up output for CCD bias power supply

CH6 is an inverting output for negative CCD bias power supply

CH7 is a high voltage step-up output for driving WLED

For the CH2, the step-up or step-down converter, operation mode can be selected by the SEL pin. Among all CHs, there are 5 CHs with the built-in internal compensation. The RT9971 also provides a transformerless inverting converter for supplying the CCD power. For the synchronous step-up and step down converters, the efficiency can be up to 95%. The IC provides load disconnection for CH 1 and CH 5. The IC has selectable RTC\_LDO/SW1 that can be determined by the CN pin.

The RT9971 is able to support Li-ion and 2AA battery applications. The RT9971 provides WLED open protection, current limit, thermal shutdown protection, over voltage and under voltage protection to achieve complete protection. The RT9971 is available in WQFN-40L 5x5 package.

### Features

- | **One Synchronous Step-Up or Step-Down Selectable Convertor**
- | **Support 2AA or Li-ion Battery Applications**
- | **Preset On/Off Sequence**
- | **5 CHs with Internal Compensation**
- | **All Power Switches Integrated**
- | **Up to 95% Efficiency**
- | **100% (max) Duty Cycle for Step-Down Converter**
- | **Adjustable Output Voltage**
- | **LED PWM Dimming Control**
- | **LED Open Protection**
- | **Transformerless Inverting Converter for CCD**
- | **Fixed 1MHz Switching Frequency at CH1 to CH7**
- | **RTC\_LDO/SW1 Selectable by CN Pin**
- | **40-Lead WQFN Package**
- | **RoHS Compliant and Halogen Free**

### Applications

- | Digital Still Camera
- | PDA
- | Portable Device

### Ordering Information

RT9971 □ □

- Package Type  
QW : WQFN-40L 5x5 (W-Type)
- Lead Plating System  
G : Green (Halogen Free and Pb Free)

Note :

Richtek products are :

- } RoHS compliant and compatible with the current requirements of IPC/JEDEC J-STD-020.
- } Suitable for use in SnPb or Pb-free soldering processes.

Pin Configurations

(TOP VIEW)

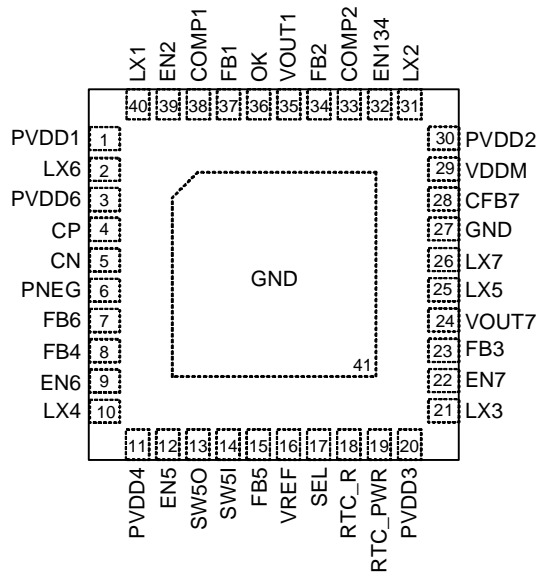

WQFN-40L 5x5

**Typical Application Circuit**

For 2AA

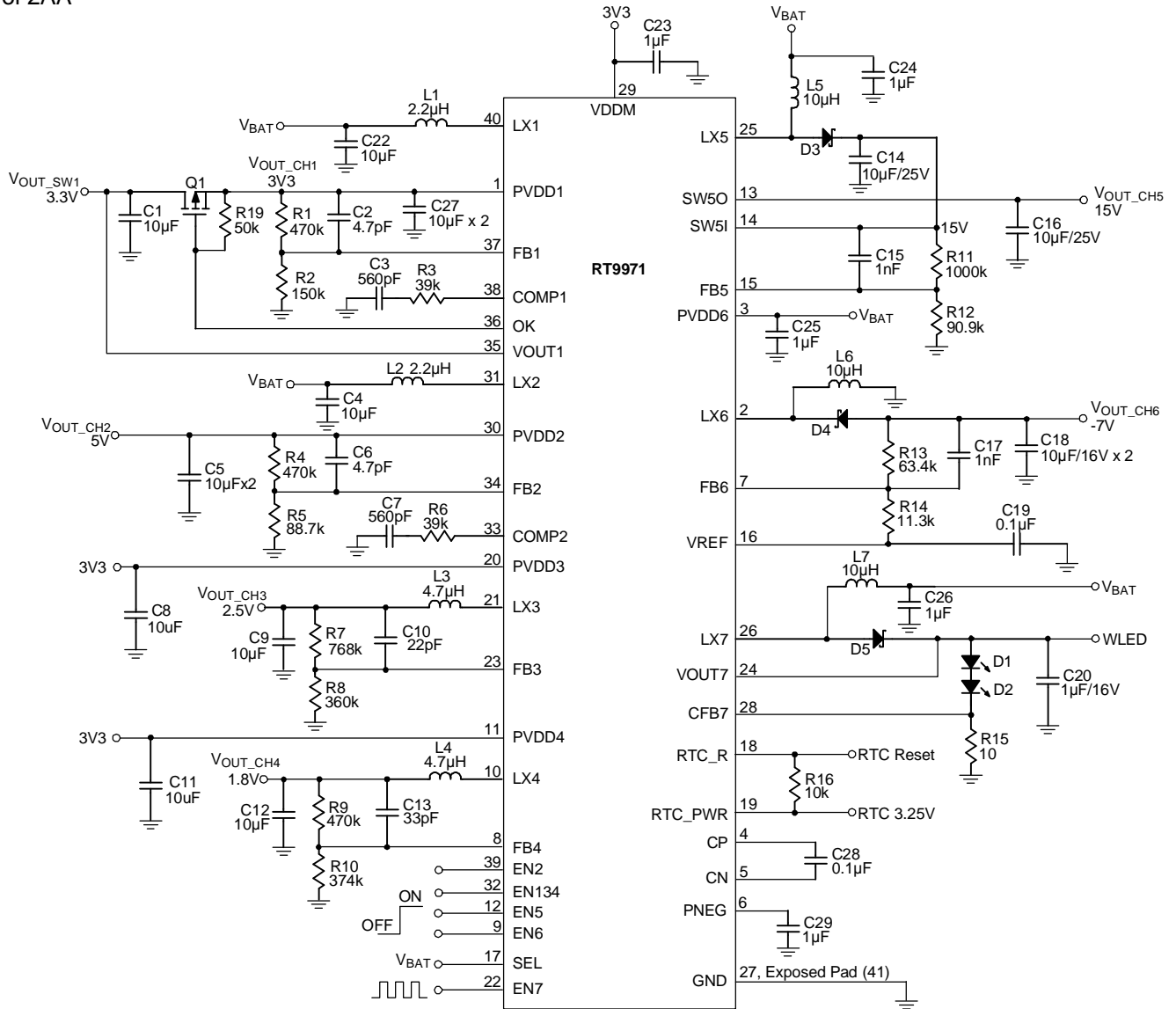

Note :

- (1) SEL = High, CH2 is Step -Up, CN Connect to CAP
- (2) V<sub>BAT</sub> = 1.8V to 3.2V

**Timing Diagram**

Power On Sequence : CH1 Step -Up 3.3V→CH3 Step -Down 2.5V→CH4 Step -Down 1.8V→(CH2 Step -Up 5V and SW1 3.3V)

Power Off Sequence : (CH2 Step -Up 5V and SW1 3.3V) →CH4 Step -Down 1.8V→ CH3 Step -Down 2.5V→ CH1 Step -Up 3.3V

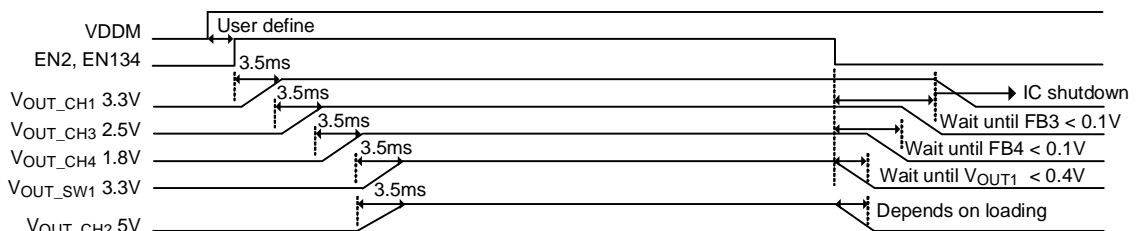

For Li-ion

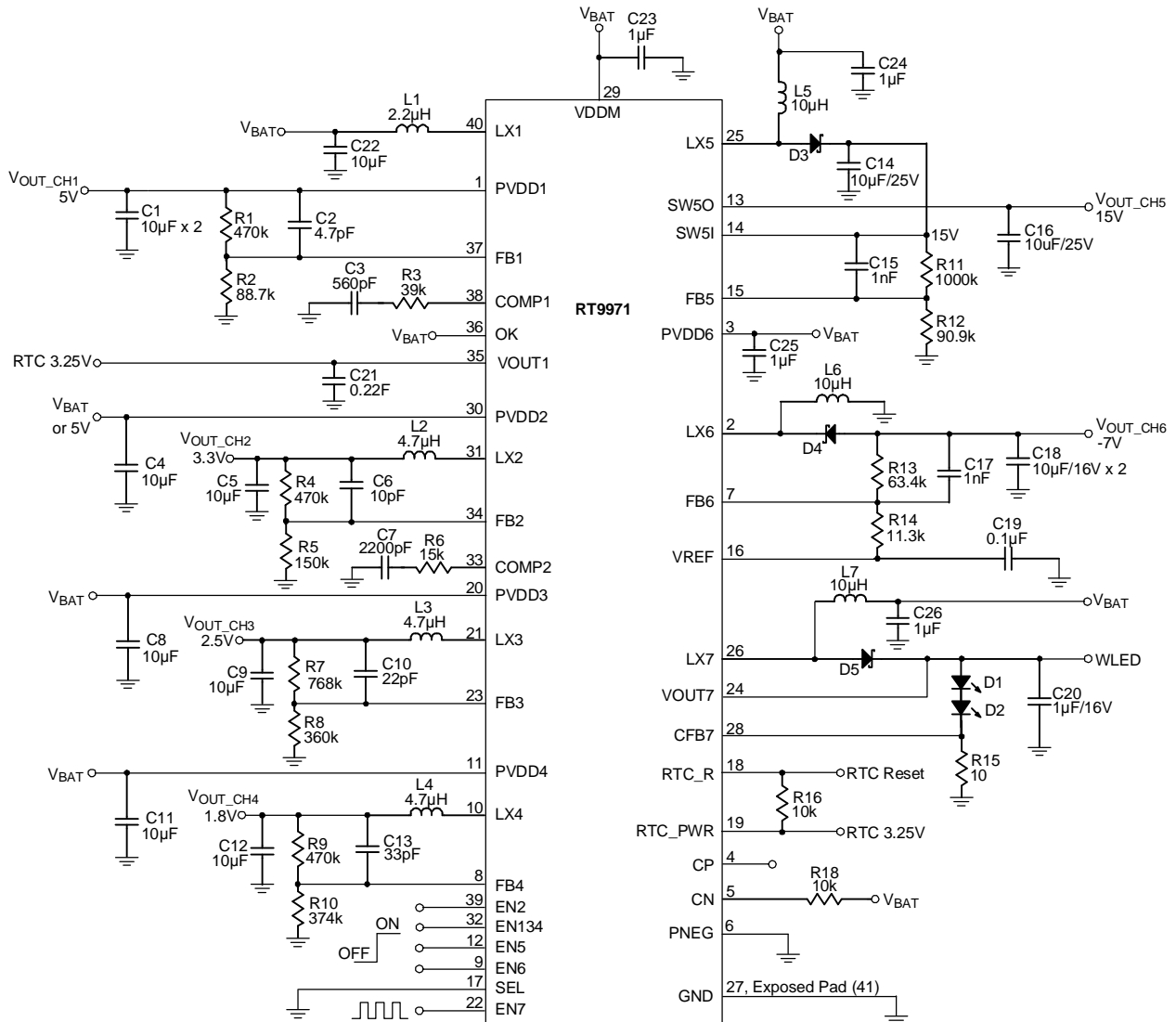

Note :

- (1) SEL = Low, CH2 is Step -Down, CN Pull High
- (2) V<sub>BAT</sub> = 2.7V to 4.2V

## Timing Diagram

Power On Sequence : CH1 Step -Up 5V→CH3 Step -Down 2.5V→CH4 Step -Down 1.8V→CH2 Step -Down 3.3V  
 Power Off Sequence : CH2 Step -Down 3.3V→CH4 Step -Down 1.8V→CH3 Step -Down 2.5V→CH1 Step -Up 5V

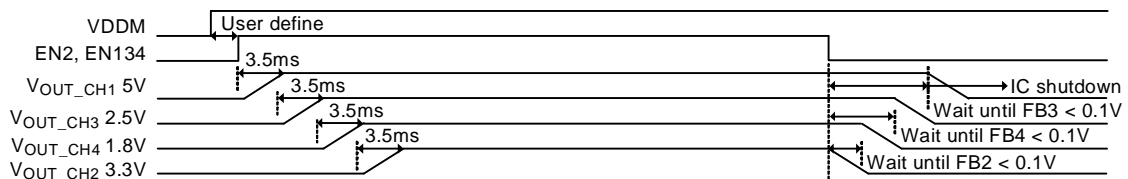

**Table 1. Recommended Components for the Typical Application Circuit**

Channel	CH3					
Formula	$V_{OUT\_CH3} = (1+R7/R8) \times 0.8$					
$V_{OUT\_CH3}$ (V)	2.5	1.8	1.5	1.3	1.2	1
L3 (mH)	4.7	4.7	4.7	4.7	4.7	4.7
R7 (k $\Omega$ )	768	470	330	237	187	23.2
R8 (k $\Omega$ )	360	374	374	374	374	93.1
C10 (pF)	22	33	47	68	82	47
C9 (mF)	10	10	10	10	10	10

Channel	CH4					
Application	$V_{OUT\_CH4} = (1+R9/R10) \times 0.8$					
$V_{OUT\_CH4}$ (V)	2.5	1.8	1.5	1.3	1.2	1
L4 (mH)	4.7	4.7	4.7	4.7	4.7	4.7
R9 (k $\Omega$ )	768	470	330	237	187	23.2
R10 (k $\Omega$ )	360	374	374	374	374	93.1
C13 (pF)	22	33	47	68	82	47
C12 (mF)	10	10	10	10	10	10

Channel	CH5					
Formula	$V_{OUT\_CH5} = (1+R11/R12) \times 1.25$					
$V_{OUT\_CH5}$ (V)	12	13	14	15	15.5	16
L5 (mH)	10	10	10	10	10	10
R11 (k $\Omega$ )	820	820	953	1000	820	886
R12 (k $\Omega$ )	95.3	86.6	93.1	90.9	71.5	75
C15 (pF)	1000	1000	1000	1000	1000	1000
C16 (mF)	10/16V	10/16V	10/25V	10/25V	10/25V	10/25V

Channel	CH6				
Formula	$V_{OUT\_CH6} = (R13/R14) \times (-1.25)$ * R13+R14 <90k				
$V_{OUT\_CH6}$ (V)	-6	-6.3	-7	-7.5	-8
L6 (mH)	10	10	10	10	10
R13 (k $\Omega$ )	57.6	69.8	63.4	68	68
R14 (k $\Omega$ )	12	13.7	11.3	11.3	10.5
C17 (pF)	1000	1000	1000	1000	1000
C18 (mF)	10 x 2pcs.	10 x 2pcs.	10 x 2pcs.	10 x 2pcs.	10 x 2pcs.

## Functional Pin Description

Pin No.	Pin Name	Pin Function
1	PVDD1	Power Output of CH1.
2	LX6	Switch Node of CH6. High impedance in shutdown mode.
3	PVDD6	Power Input of CH6.
4	CP	Charge Pump External Driver.
5	CN	Charge Pump External Driver.
6	PNEG	Negative Output of Charge Pump.
7	FB6	Feedback Input of CH6. High impedance in shutdown mode.
8	FB4	Feedback Input of CH4. High impedance in shutdown mode.
9	EN6	Enable Control Input of CH6.
10	LX4	Switch Node of CH4. High impedance in shutdown mode.
11	PVDD4	Power Input of CH4.
12	EN5	Enable Control Input of CH5.
13	SW5O	Output of CH5 Load Disconnect.
14	SW5I	Input of CH5 Load Disconnect.
15	FB5	Feedback Input of CH5. High impedance in shutdown mode.
16	VREF	1.25V Reference Output.
17	SEL	Li-ion or 2AA Select. Logic state can not be changed during operation.
18	RTC_R	RTC_Reset Output.
19	RTC_PWR	Power Input of RTC_Reset.
20	PVDD3	Power Input of CH3.
21	LX3	Switch Node of CH3. High impedance in shutdown mode.
22	EN7	Enable Control Input of CH7.
23	FB3	Feedback Input of CH3. High impedance in shutdown mode.
24	VOUT7	Sense Input for CH7 Output Voltage.
25	LX5	Switch Node of CH5. High impedance in shutdown mode.
26	LX7	Switch Node of CH7. High impedance in shutdown mode.
27, 41 (Exposed Pad)	GND	Ground. The exposed pad must be soldered to a large PCB and connected to GND for maximum thermal dissipation.
28	CFB7	Feedback Input of CH7.
29	VDDM	IC Analog Power Input.
30	PVDD2	Power Input of CH2 step-down converter, or power output of CH2 step-up converter.
31	LX2	Switch Node of CH2. High impedance in shutdown mode.
32	EN134	Enable Control Input of CH1, CH3 and CH4.
33	COMP2	Compensation of CH2. Pull to GND in shutdown mode.
34	FB2	Feedback input of CH2. High impedance in shutdown mode.
35	VOUT1	CN is set to low or floating : Sense Pin for CH1 Output Voltage. High impedance in shutdown. CN is set to High: Output pin of RTC_LDO.
36	OK	CN is set to low or floating : External Switch Control. High impedance in shutdown. CN is set to High : Power input pin of RTC_LDO.
37	FB1	Feedback Input of CH1. High impedance in shutdown mode.
38	COMP1	Compensation of CH1. Pull to GND in shutdown mode.
39	EN2	Enable Control Input of CH2.
40	LX1	Switch Node of CH1. High impedance in shutdown mode.

**Function Block Diagram**

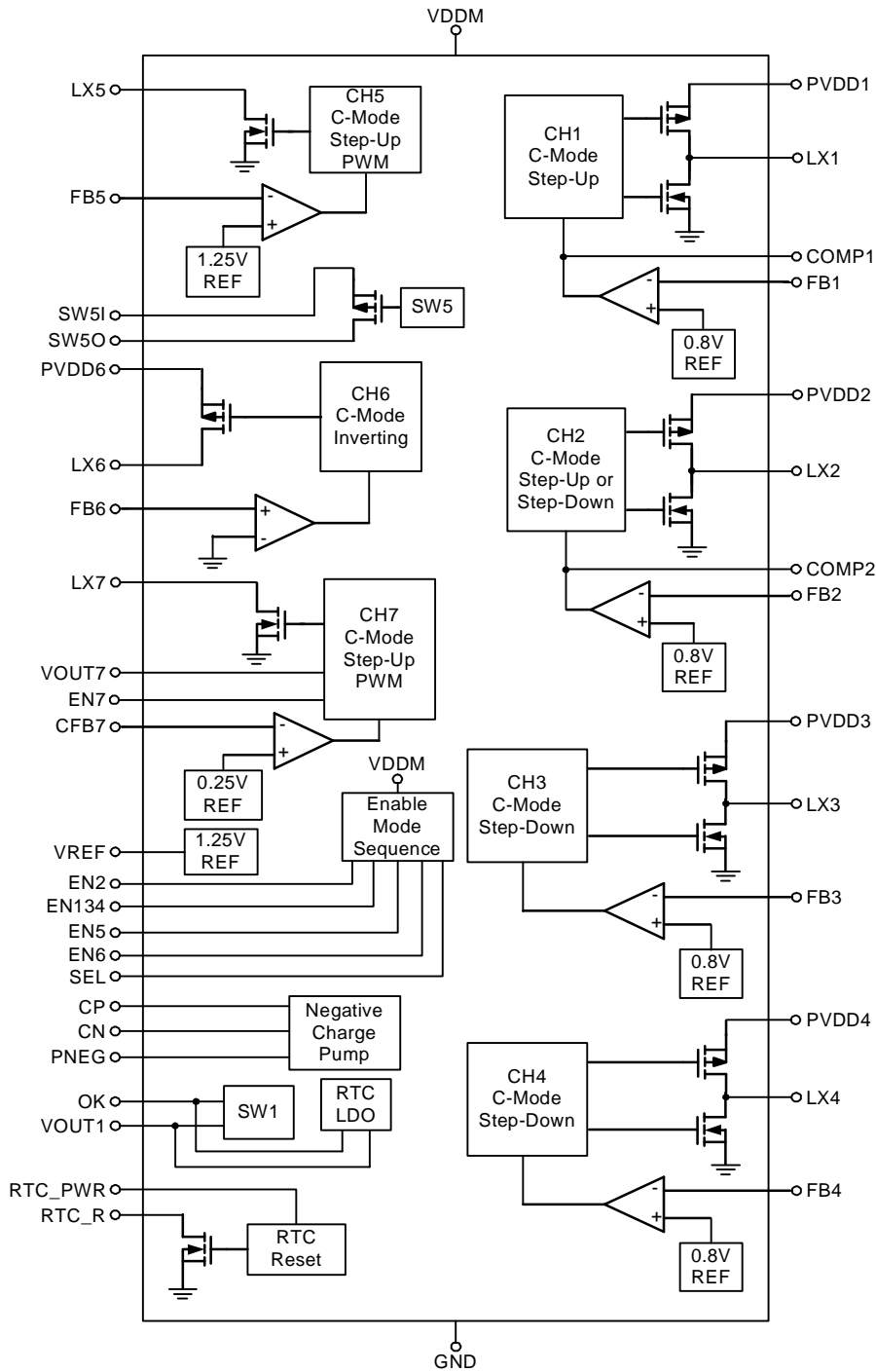

**Timing Diagram**

CH5 and CH6 Timing Diagram

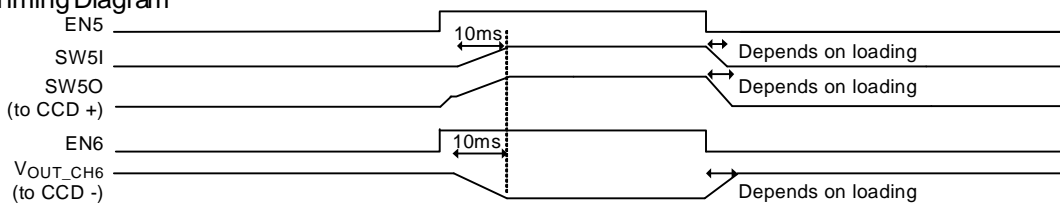

## Absolute Maximum Ratings (Note 1)

Supply Voltage, $V_{DDM}$ -----	-0.3V to 7V
Power Switch :	
LX1, LX2, LX3, LX4 -----	-0.3V to 6.5V
LX5, LX7, SW5I, SW5O, VOUT7 -----	-0.3V to 21V
LX6 -----	(PVDD6 - 14V) to (PVDD6 + 0.3V)
The Other Pins -----	-0.3V to 6.5V
Power Dissipation, $P_D$ @ $T_A = 25^\circ\text{C}$	
WQFN 40L 5x5 -----	2.778W
Package Thermal Resistance (Note 2)	
WQFN 40L 5x5, $\theta_{JA}$ -----	36°C/W
WQFN 40L 5x5, $\theta_{JC}$ -----	7°C/W
Junction Temperature -----	150°C
Lead Temperature (Soldering, 10 sec.) -----	260°C
Storage Temperature Range -----	-65°C to 150°C
ESD Susceptibility (Note 3)	
HBM (Human Body Mode) -----	2kV
MM (Machine Mode) -----	200V

## Recommended Operating Conditions (Note 4)

Junction Temperature Range -----	-40°C to 125°C
Ambient Temperature Range -----	-40°C to 85°C

## Electrical Characteristics

( $V_{DDM} = 3.3\text{V}$ ,  $T_A = 25^\circ\text{C}$ , unless otherwise specified)

Parameter	Symbol	Test Condition	Min	Typ	Max	Unit
<b>Supply Voltage</b>						
VDDM Operating Voltage	$V_{DDM}$		2.7	--	5.5	V
VDDM Startup Voltage	$V_{ST}$		1.5	--	--	V
VDDM Over Voltage Protection			6	6.25	6.5	V
<b>Supply Current</b>						
Shutdown Supply Current into VDDM	$I_{OFF}$	All EN = 0, CN = 3.3V	--	5	10	$\mu\text{A}$
CH1 (Syn-Step-Up) : Supply Current into VDDM	$I_{Q1}$	Non Switching, EN134 = 3.3V	--	--	800	$\mu\text{A}$
CH2 (Syn-Step-Up or Syn-Step-Down) : Supply Current into VDDM	$I_{Q2}$	Non Switching, EN2 = 3.3V	--	--	800	$\mu\text{A}$
CH3 (Syn-Step-Down) : Supply Current into VDDM	$I_{Q3}$	Non Switching, EN134 = 3.3V	--	--	800	$\mu\text{A}$
CH4 (Syn-Step-Down) : Supply Current into VDDM	$I_{Q4}$	Non Switching, EN134 = 3.3V	--	--	800	$\mu\text{A}$
CH5 (Asyn-Step-Up) : Supply Current into VDDM	$I_{Q5}$	Non Switching, EN5 = 3.3V	--	--	800	$\mu\text{A}$
CH6 (Inverting) + Charge pump : Supply Current into VDDM	$I_{Q6}$	Non Switching, EN6 = 3.3V PVDD6 = 3.3V	--	--	800	$\mu\text{A}$
CH7 (WLED): Supply Current into VDDM	$I_{Q7}$	Non Switching, EN7 = 3.3V	--	--	800	$\mu\text{A}$

*To be continued*



Parameter	Symbol	Test Condition	Min	Typ	Max	Unit
<b>Oscillator</b>						
CH1,2,3,4, 5, 6, 7 Operating Frequency	$f_{OSC}$		900	1000	1100	kHz
CH1 Maximum Duty Cycle (Step-Up)		$V_{FB1} = 0.7V$	80	83	86	%
CH2 Maximum Duty Cycle (Step-Up)		$V_{FB2} = 0.7V$	80	83	86	%
CH2 Maximum Duty Cycle (Step-Down)		$V_{FB2} = 0.7V$	--	--	100	%
CH3 Maximum Duty Cycle (Step-Down)		$V_{FB3} = 0.7V$	--	--	100	%
CH4 Maximum Duty Cycle (Step-Down)		$V_{FB4} = 0.7V$	--	--	100	%
CH5 Maximum Duty Cycle (Step-Up)		$V_{FB5} = 1.15V$	91	94	97	%
CH6 Maximum Duty Cycle (Inverting)		$V_{FB6} = 0.1V$	91	94	97	%
CH7 Maximum Duty Cycle (WLED)		$V_{FB7} = 0.15V$	91	94	97	%
<b>Feedback Regulation Voltage</b>						
Feedback Regulation Voltage @ FB1, FB2, FB3, FB4			0.788	0.8	0.812	V
Feedback Regulation Voltage @ FB5			1.237	1.25	1.263	V
Feedback Regulation Voltage @ FB6 (Inverting)			-15	0	15	mV
Feedback Regulation Voltage @ CFB7			0.237	0.25	0.263	V
OK Sink Current		OK = 1V	50	--	--	$\mu A$
<b>Reference</b>						
VREF Output Voltage	$V_{REF}$		1.237	1.25	1.263	V
VREF Load Regulation		$0\mu A < I_{REF} < 200\mu A$	--	--	10	mV
<b>Negative Charge Pump</b>						
PVDD6 Low Threshold to Start Pump			3.4	3.6	3.8	V
PVDD6 Hysteresis Gap to Stop Pump			0.1	0.3	0.5	V
(PVDD6 – PNEG) Clamped Voltage		PVDD6 = 3.3V	4.1	4.5	4.9	V
<b>Power Switch</b>						
CH1 On Resistance of MOSFET	$R_{DS(ON)}$	P-MOSFET, PVDD1 = 3.3V	--	150	--	m $\Omega$
		N-MOSFET, PVDD1 = 3.3V	--	150	--	
CH1 Current Limitation (Step-Up)			--	3	--	A
CH2 On Resistance of MOSFET	$R_{DS(ON)}$	P-MOSFET, PVDD2 = 3.3V	--	150	--	m $\Omega$
		N-MOSFET, PVDD2 = 3.3V	--	150	--	
CH2 Current Limitation (Step-Down)			--	1.5	--	A
CH2 Current Limitation (Step-Up)			--	3	--	A
CH3 On Resistance of MOSFET	$R_{DS(ON)}$	P-MOSFET, PVDD3 = 3.3V	--	200	--	m $\Omega$
		N-MOSFET, PVDD3 = 3.3V	--	200	--	
CH3 Current Limitation (Step-Down)			--	1.5	--	A
CH4 On Resistance of MOSFET	$R_{DS(ON)}$	P-MOSFET, PVDD4 = 3.3V	--	200	--	m $\Omega$
		N-MOSFET, PVDD4 = 3.3V	--	200	--	
CH4 Current Limitation (Step-Down)			--	1.5	--	A
CH5 Load Disconnect MOSFET		P-MOSFET, SW51 = 3.3V	--	0.5	--	$\Omega$
CH5 On Resistance of MOSFET		N-MOSFET	--	0.5	--	$\Omega$
CH5 Current Limitation		N-MOSFET	--	1.2	--	A

*To be continued*

Parameter	Symbol	Test Condition	Min	Typ	Max	Unit
CH6 On Resistance of MOSFET		P-MOSFET, PVDD6 = 3.3V	--	0.5	--	$\Omega$
CH6 Current Limitation		P-MOSFET	--	1.5	--	A
CH7 On Resistance of MOSFET		N-MOSFET	--	1	--	$\Omega$
CH7 Current Limitation		N-MOSFET	--	0.8	--	A
<b>Protection</b>						
Over Voltage Protection of PVDD1 and PVDD2			6	6.25	6.5	V
Under Voltage Protection of VOUT1			--	1.75	--	V
Over Voltage Protection of SW5I			18	--	21	V
Over Voltage Protection of VOUT7			12	--	16	V
CH5 Load Disconnect UVP of SW5O			0.35	0.4	0.45	V
Under Voltage Protection of FB2 (Step-Down)			--	0.4	--	V
Under Voltage Protection of FB3			--	0.4	--	V
Under Voltage Protection of FB4			--	0.4	--	V
Under Voltage Protection of FB5			--	0.8	--	V
Under Voltage Protection of FB6			--	0.4	--	V
Protection Fault Delay			--	100	--	ms
<b>Control</b>						
EN134, EN2, EN5, EN6, EN7 Input High Level Threshold			1.3	--	--	V
EN134, EN2, EN5, EN6, EN7 Input Low Level Threshold			--	--	0.4	V
EN134, EN2, EN5, EN6, EN7 Sink Current			--	2	6	$\mu$ A
SEL Input High Level Threshold			1.3	--	--	V
SEL Input Low Level Threshold			--	--	0.4	V
SEL Sink Current		SEL = 3.3V	--	2	6	$\mu$ A
<b>Thermal Protection</b>						
Thermal Shutdown	$T_{SD}$		125	160	--	$^{\circ}$ C
Thermal Shutdown Hysteresis	$\Delta T_{SD}$		--	20	--	$^{\circ}$ C
<b>RTC Reset</b>						
RTC_PWR Reset Threshold			1.57	1.6	1.63	V
Hysteresis			--	16	--	mV
Standby Current		RTC_PWR = 3V	--	2	4	$\mu$ A
RTC_R Rising Delay Time			35	55	75	ms
RTC_R Sink Capability		RTC_R = 0.5V, RTC_PWR = 1.5V	4	--	--	mA

To be continued

Parameter	Symbol	Test Condition	Min	Typ	Max	Unit
<b>RTC LDO, CN = High</b>						
Input Voltage Range	$V_{IN}$		--	--	5.5	V
Standby Current		$V_{IN} = 4.2V$	--	5	8	$\mu A$
Output Voltage	$V_{OUT}$	$I_{OUT} = 0mA$	--	3.25	3.3	V
Maximum Output Current		$V_{IN} = 4.2V$	60	--	--	mA
Dropout Voltage	$V_{DROP}$	$I_{OUT} = 20mA$	--	--	200	mV

**Note 1.** Stresses listed as the above "Absolute Maximum Ratings" may cause permanent damage to the device. These are for stress ratings. Functional operation of the device at these or any other conditions beyond those indicated in the operational sections of the specifications is not implied. Exposure to absolute maximum rating conditions for extended periods may remain possibility to affect device reliability.

**Note 2.**  $\theta_{JA}$  is measured in the natural convection at  $T_A = 25^\circ C$  on a high effective four layers thermal conductivity test board of JEDEC 51-7 thermal measurement standard. The case point of  $\theta_{JC}$  is on the exposed pad for the WQFN package.

**Note 3.** Devices are ESD sensitive. Handling precaution is recommended.

**Note 4.** The device is not guaranteed to function outside its operating conditions.

Typical Operating Characteristics

CH1 Step-Up Efficiency vs. Output Current

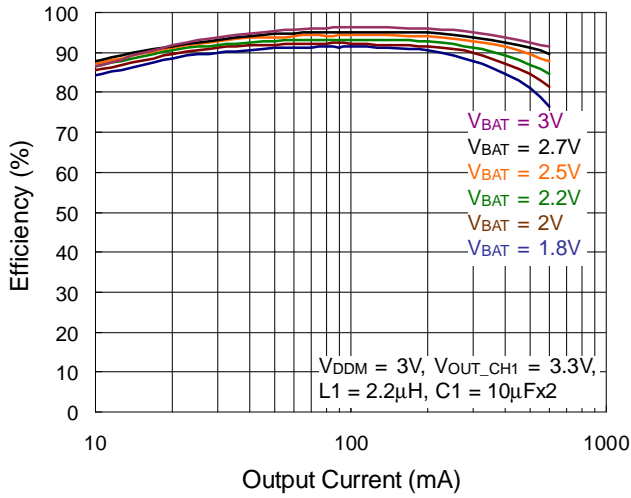

CH1 Step-Up Efficiency vs. Output Current

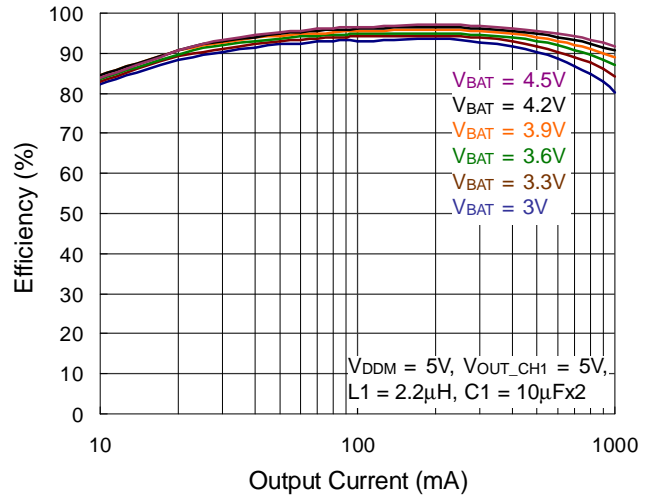

CH2 Step-Up Efficiency vs. Output Current

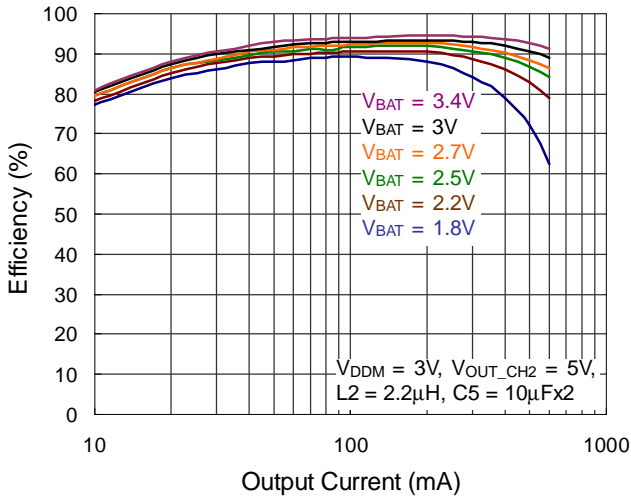

CH2 Step-Down Efficiency vs. Output Current

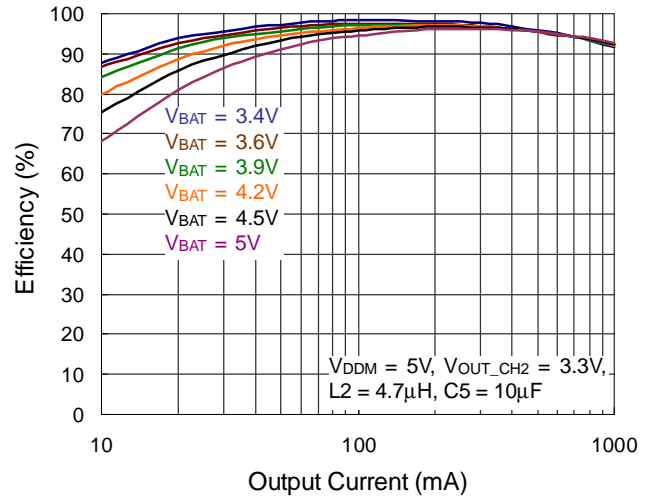

CH3 Step-Down Efficiency vs. Output Current

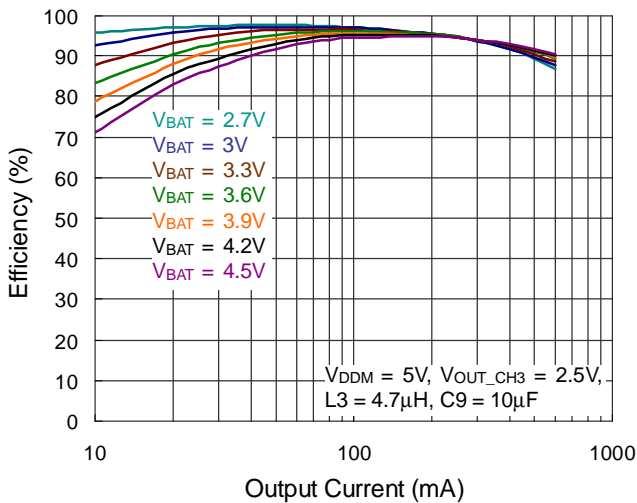

CH4 Step-Down Efficiency vs. Output Current

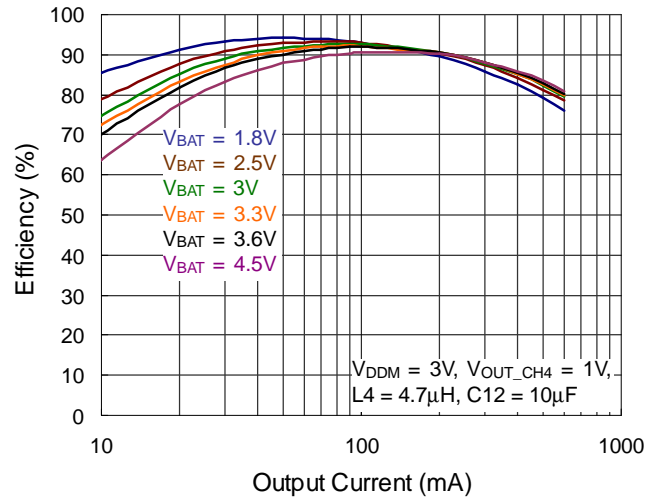

CH5 Step-Up Efficiency vs. Output Current

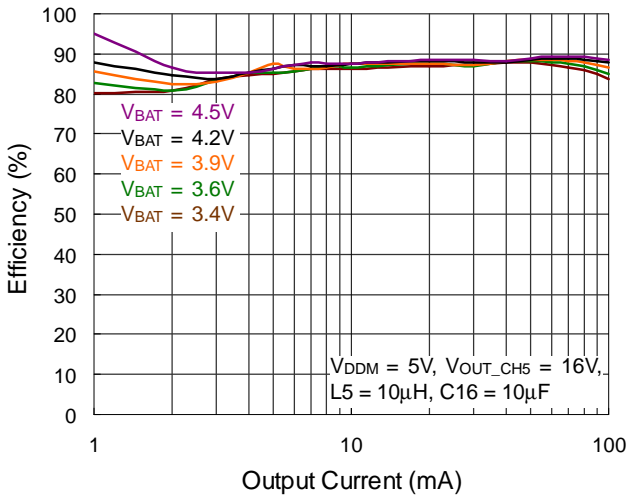

CH6 Inverting Efficiency vs. Output Current

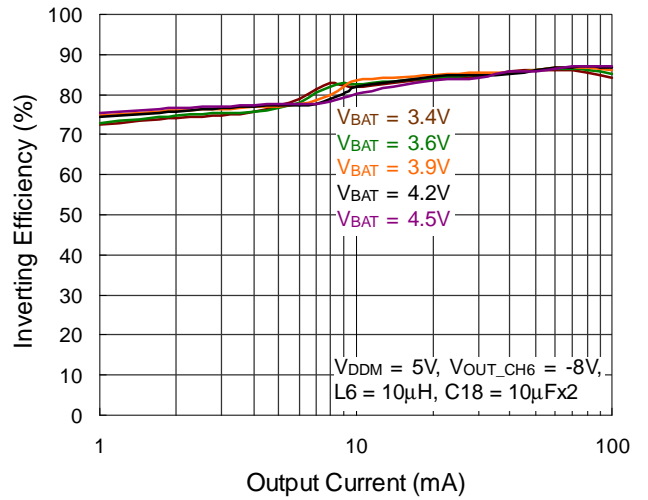

CH7 Efficiency vs. Input Voltage

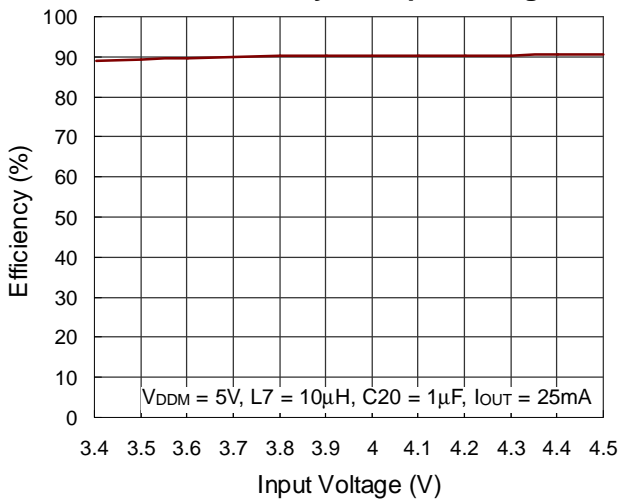

CH1 Step-Up Output Voltage vs. Output Current

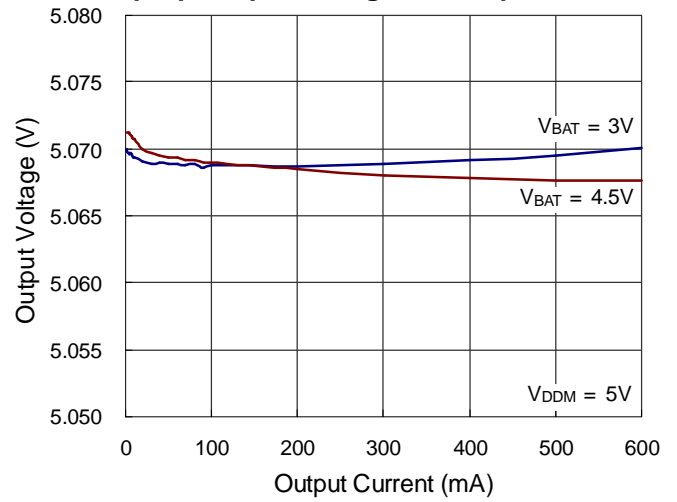

CH1 Step-Up Output Voltage vs. Output Current

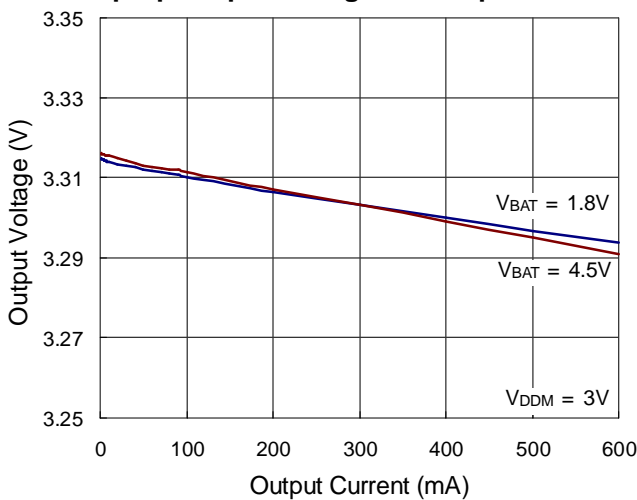

CH2 Step-Down Output Voltage vs. Output Current

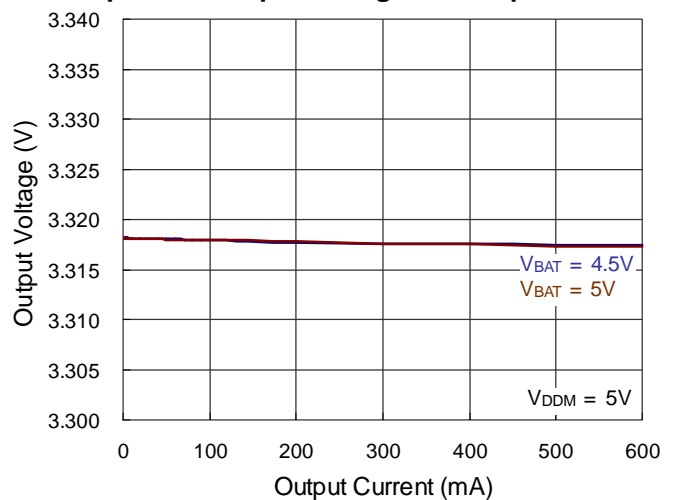

CH2 Step-Up Output Voltage vs. Output Current

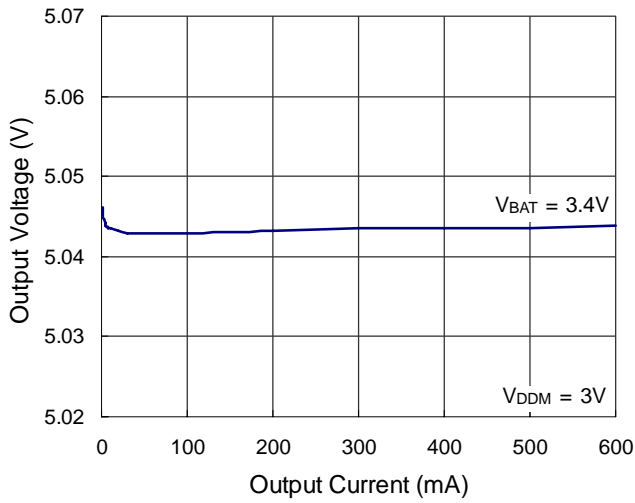

CH3 Step-Down Output Voltage vs. Output Current

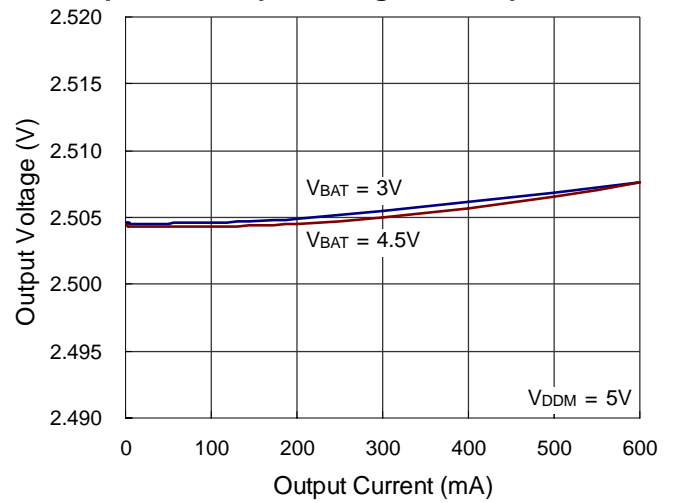

CH4 Step-Down Output Voltage vs. Output Current

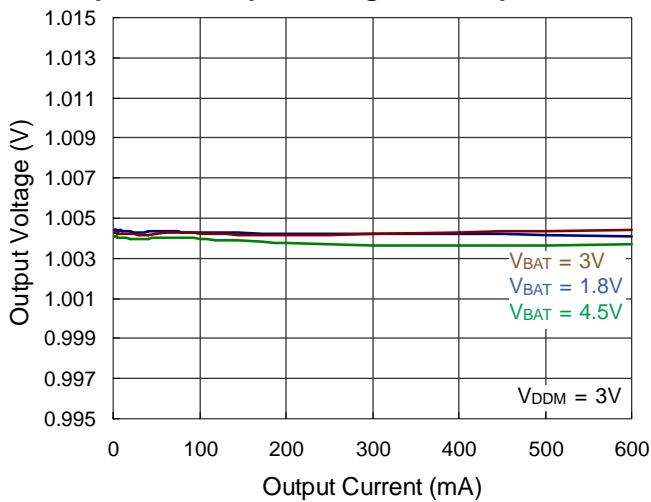

CH5 Step-Up Output Voltage vs. Output Current

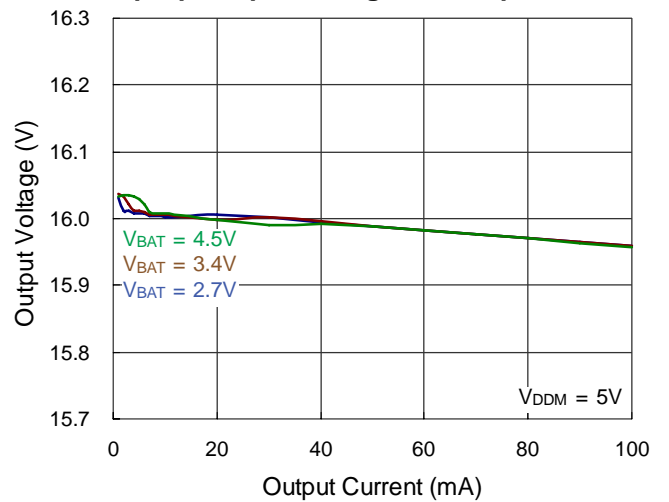

CH6 Inverting Output Voltage vs. Output Current

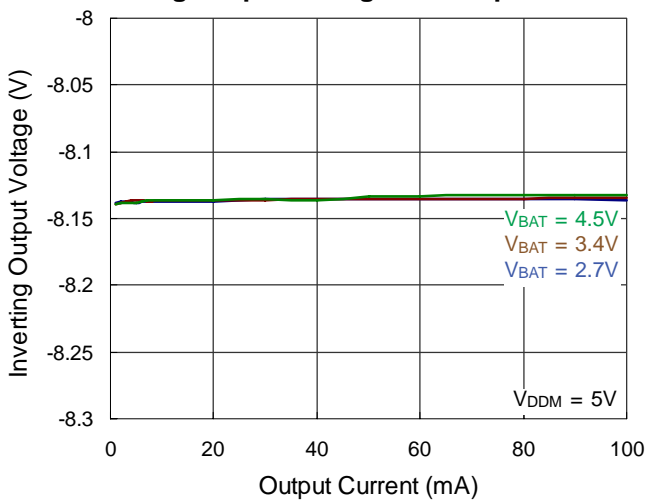

Power On

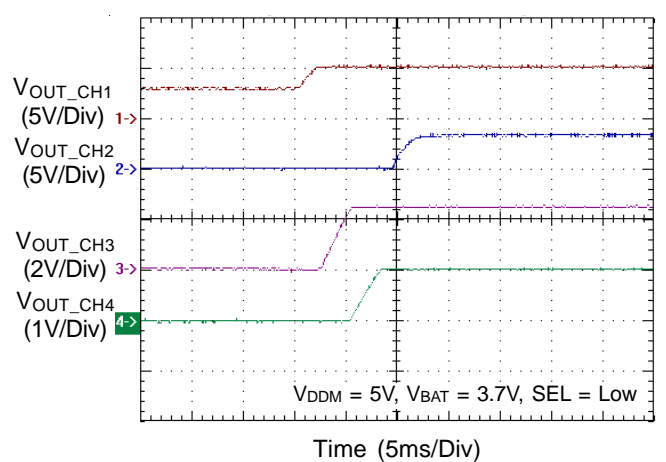

Power Off

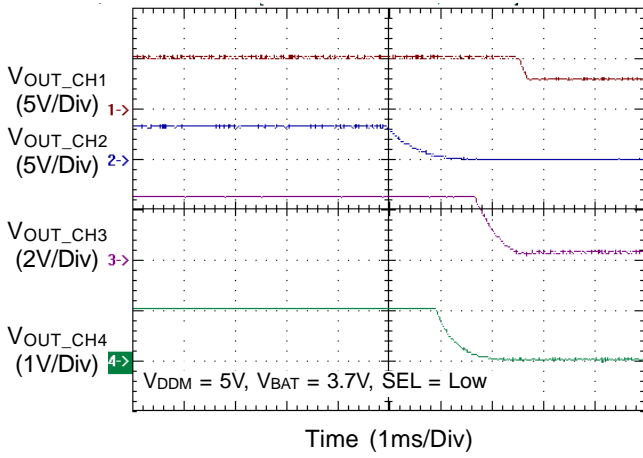

CH1 Output Voltage Ripple

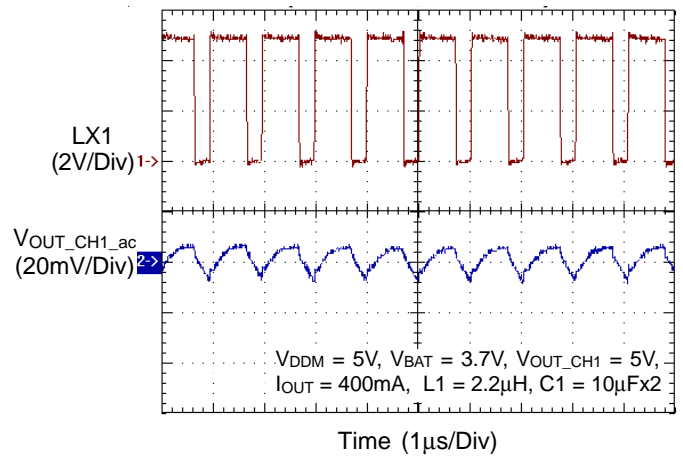

CH2 Output Voltage Ripple

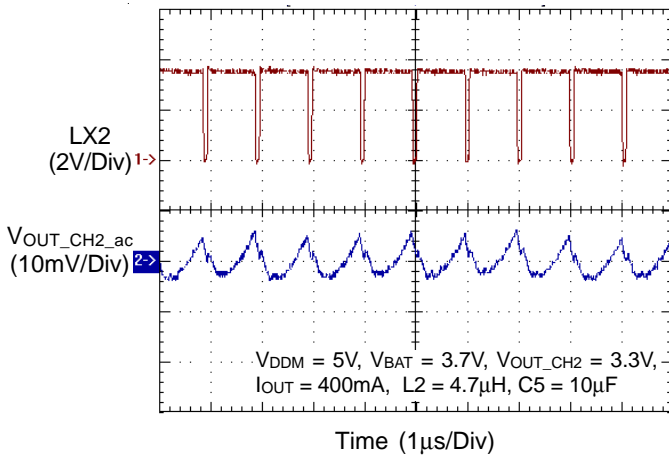

CH3 Output Voltage Ripple

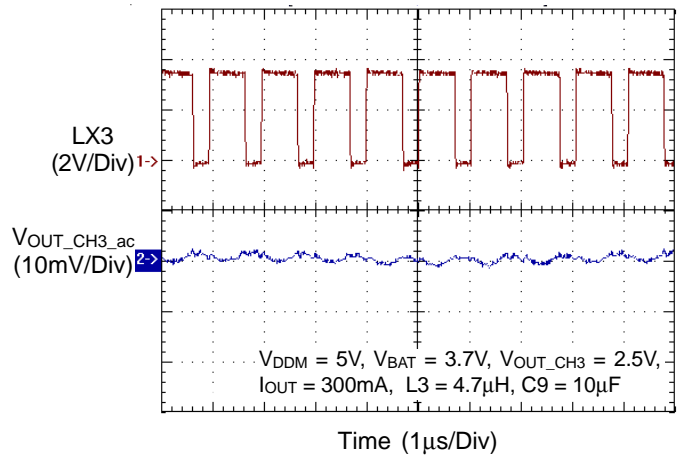

CH5 Output Voltage Ripple

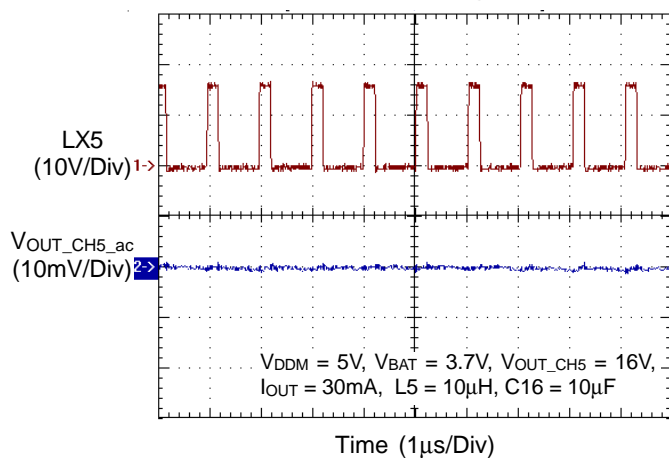

CH6 Output Voltage Ripple

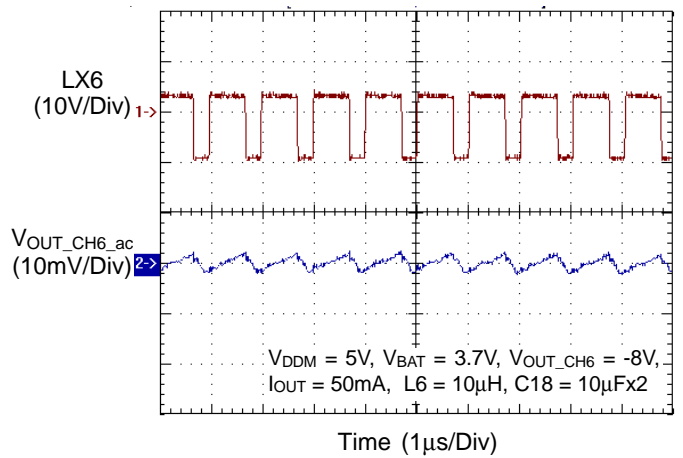

CH1 Load Transient Response

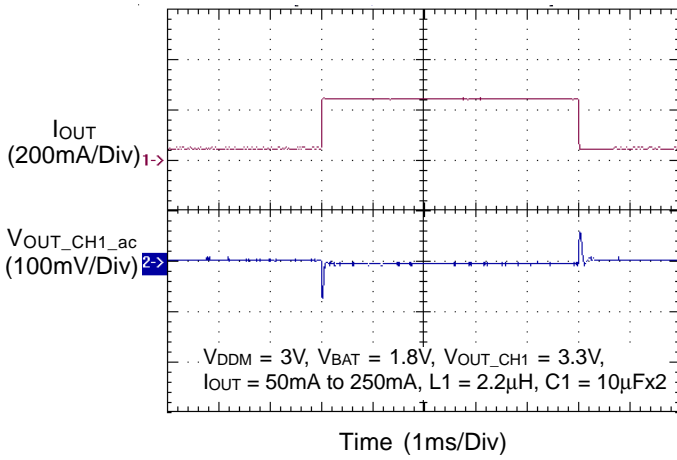

CH2 Load Transient Response

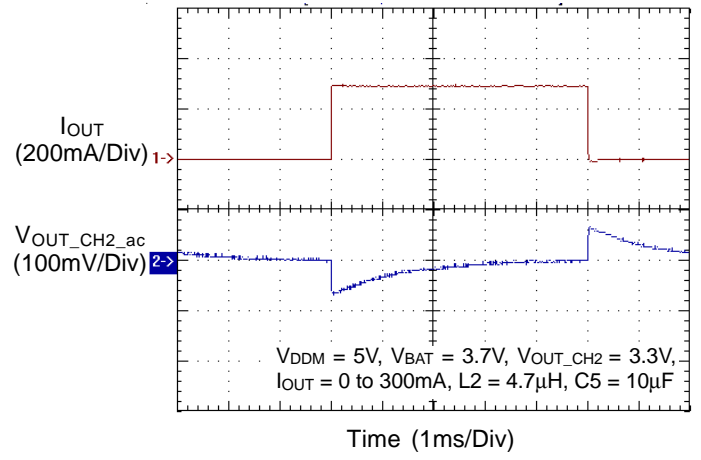

CH3 Load Transient Response

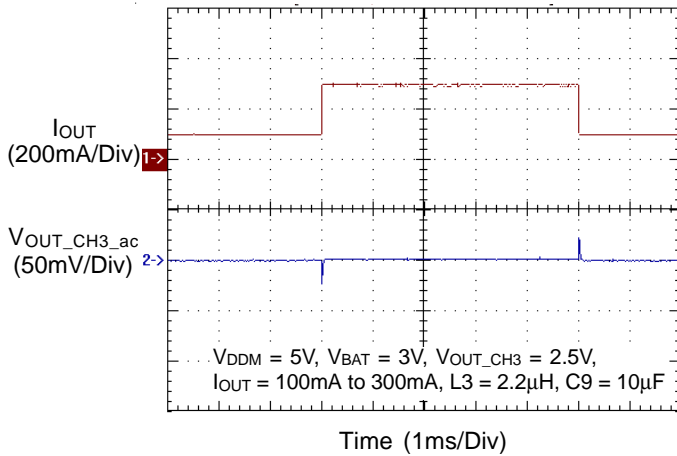

CH4 Load Transient Response

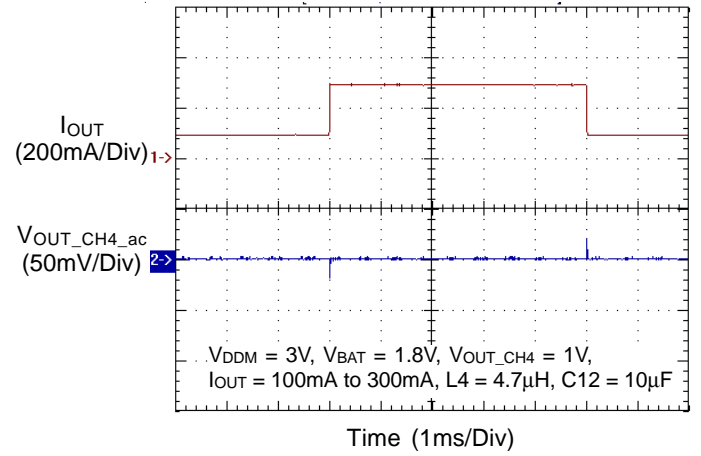

CH5 Load Transient Response

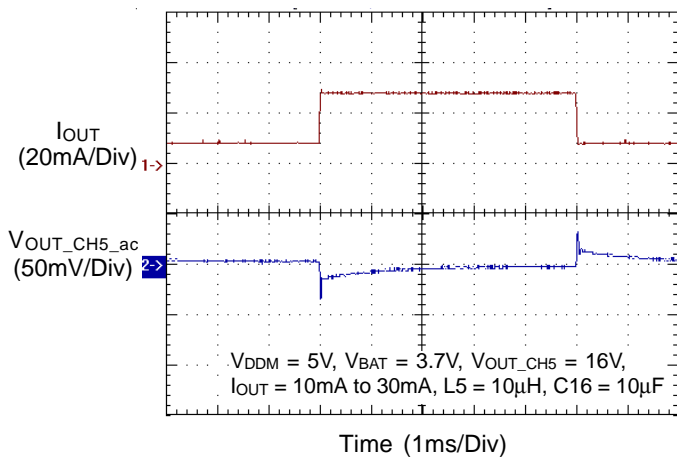

CH6 Load Transient Response

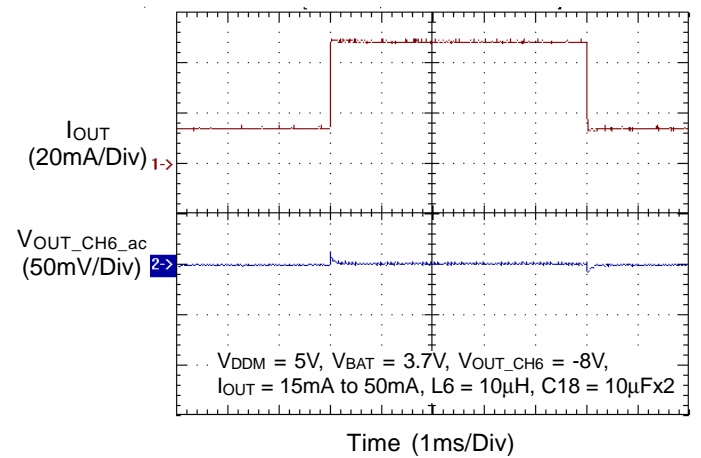



**Application information**

The RT9971 includes the following seven DC/DC converter CHs to build a multiple-output power-supply system.

CH1 : Step-up synchronous current mode DC/DC converter with internal power MOSFETs. The output voltage could be load disconnected by a switch controller and an external P-MOSFET.

CH2 : Selectable step-up or step-down synchronous current mode DC/DC converter with internal power MOSFETs.

CH3 : Step-down synchronous current mode DC/DC converter with internal power MOSFETs and internal compensation network.

CH4 : Step-down synchronous current mode DC/DC converter with internal power MOSFETs and internal compensation network.

CH5 : Step-up asynchronous current mode DC/DC converter with internal power MOSFET and internal compensation network. The output voltage could be load disconnected by an internal P-MOSFET.

CH6 : Inverting current mode DC/DC converter with internal power P-MOSFET and internal compensation network.

CH7 : Current mode WLED driver with internal power N-MOSFET and internal compensation network. This CH also provides open LED protection.

SW1 : Load disconnect controller.

SW5 : Load disconnect switch for CH5

CH1 to CH7 operate in PWM mode with 1MHz constant frequency under moderate to heavy loading.

RTC\_LDO : Low quiescent current, high output voltage accuracy LDO for Real Time Clock.

RTC\_Reset : Accurate voltage detector for RTC LDO.

**CH1: Synchronous Step-Up DC/DC Converter**

The CH1 is a synchronous step-up converter for motor or DSC system I/O power. The converter operates at fixed frequency and PWM Current Mode. The CH1 converter integrates internal MOSFETs, compensation network and synchronous rectifier for up to 95% efficiency.

The output voltage can be set by the following equation :

$$V_{OUT\_CH1} = (1+R1/R2) \times V_{FB1}$$

Where  $V_{FB1}$  is 0.8V typically.

**SW1**

SW1 is an open drain controller to drive an external P-MOSFET and then functions as a load disconnect switch for CH1. This switch features soft-start, Power On/ Off Sequence and under voltage protection functions. OK is an open drain control pin. Once CH1, CH3, and CH4's soft-start are finished, SW1 will be turned on. The OK pin is slowly pulled low and controlled with soft-start to suppress the inrush current. VOUT1 is used for SW1 soft-start and under voltage protection.

**CH2 : Synchronous Step-Up or Step-Down Selectable DC/DC Converter**

The CH2 is a synchronous step-up or step-down selectable converter for motor or DSC system I/O power.

**Mode setting**

The CH2 of the RT9971 features flexible Step-up or Step-down topology setting for either 1 x Li-ion or 2 x AA application by the SEL pin. Please refer to "Electrical Characteristics" for level of Logic-High or Logic-Low. When the CH2 operates as a Step-up converter, the SEL must be set at Logic-High. If the CH2 operates at Step-down mode, the SEL must be set at Logic-Low. In addition, please note that the logic state can not be changed during operation.

**Table 2. CH2 Mode Setting**

CH2 Operating Mode	SEL
Step-up	Logic-High
Step-down	Logic-Low

**Step-Up :**

The converter operates at fixed frequency PWM Mode, continuous current mode (CCM), and discontinuous current mode (DCM) with internal MOSFETs, compensation network and synchronous rectifier for up to 95% efficiency.

## Step-Down :

The converter operates at fixed frequency PWM mode and continuous current mode (CCM) with internal MOSFETs, compensation network and synchronous rectifier for up to 95% efficiency. The CH2 step-down converter can be operated at 100% maximum duty cycle to extend the input operating voltage range. While the input voltage is close to the output voltage, the converter enters low dropout mode.

The output voltage can be set by the following equation :

$$V_{OUT\_CH2} = (1+R4/R5) \times V_{FB2}$$

Where  $V_{FB2}$  is 0.8V typically.

## CH3 : Synchronous Step-Down DC/DC Converter

The converter operates at fixed frequency PWM mode, CCM, integrated internal MOSFETs and compensation network. The CH3 step-down converter can be operated at 100% maximum duty cycle to extend the battery operating voltage range. When the input voltage is close to the output voltage, the converter could enter low dropout mode with low output ripple.

The output voltage can be set by the following equation :

$$V_{OUT\_CH3} = (1+R7/R8) \times V_{FB3}$$

Where  $V_{FB3}$  is 0.8V typically.

## CH4 : Synchronous Step-Down DC/DC Converter

The converter operates at fixed frequency PWM mode, CCM, integrated internal MOSFETs and compensation network. The CH4 step-down converter can be operated at 100% maximum duty cycle to extend battery operating voltage range. When the input voltage is close to the output voltage, the converter could enter low dropout mode with low output ripple.

The output voltage can be set by the following equation :

$$V_{OUT\_CH4} = (1+R9/R10) \times V_{FB4}$$

Where  $V_{FB4}$  is 0.8V typically.

## CH5 : Step-Up DC/DC Converter

It integrates asynchronous step-up converter with an internal N-MOSFET, internal compensation and an external schottky diode to provide CCD positive power supply. The

converter is inactive until the SW5 soft-start procedure is finished. This feature provides load disconnect function and effectively limits inrush current at start up.

The output voltage can be set by the following equation :

$$V_{OUT\_CH5} = (1+R11/R12) \times V_{FB5}$$

Where  $V_{FB5}$  is 1.25V typically.

## SW5

SW5 is an internal switch enabled by EN5 and functions as a load disconnection for CH5. This switch features soft-start, Power On Sequence, over voltage (for SW5I) and under voltage (for SW5O) protection functions.

## CH6 : INV DC/DC Converter

This converter integrates an internal P-MOSFET and an external schottky diode to provide CCD negative power supply.

The output voltage can be set by the following equation :

$$V_{OUT\_CH6} = (R13/R14) \times (-V_{REF})$$

Where R13 and R14 are the feedback resistors connected to FB6,  $V_{REF}$  equals to 1.25V in typical.

## Charge Pumps

The charge pump will be enabled while the PVDD6 voltage is lower than 3.6V. This CH provides pump voltage to enhance P-MOSFET gate driving capability. This function is not necessary while battery is Li-ion type.

## Reference Voltage

The RT9971 provides a precise 1.25V reference voltage with sourcing capability of 100 $\mu$ A. Connect a 0.1 $\mu$ F ceramic capacitor from the VREF pin to GND. Reference voltage is enabled by connecting EN6 to logic high. Furthermore, this reference voltage is internally pulled to GND at shutdown.

## CH7 : WLED Driver

It is an asynchronous step-up converter with an internal MOSFET, internal compensation and an external schottky diode to drive up to 3 WLED. This CH also features PWM dimming control from EN7 pin and open diode protection. In addition, CH7 will be turned on until the CH4 soft-start is finished.

The current flows through WLED can be set by the following equation :

$$I \text{ (mA)} = [250\text{mV}/R(\Omega)] \times \text{Duty (\%)}$$

R : Current sense resistor from CFB7 to GND.

Duty: PWM dimming by EN7 pin. Dimming frequency range is from 30kHz to 100kHz.

Hold EN7 low for more than 64μs will turn off CH7.

**RTC\_Reset**

The RT9971 provides an accurate voltage detector for RTC\_LDO voltage detection. It is used to detect whether RTC\_LDO output voltage is ready or not. Its power pin is RTC\_PWR and output pin is RTC\_R. The output pin is an open drain N-MOSFET and the sink capability is above 4mA. Once the RTC\_PWR pin reaches 1.6V, it will count for about 55ms, then the RTC\_R will go high.

**RTC\_LDO**

The RT9971 provides a LDO for real time clock. The LDO function has features of low quiescent current (5μA) and high output voltage accuracy since this LDO is running all the time, even when the system is shutdown. In addition, LDO share "OK" and "VOUT1" pin with SW1 and the function is decided by "CN" pin. Following table is used to select LDO or SW1.

**Table 3. RTC\_LDO and SW1 Setting**

Function	CN
RTC_LDO	Logic-High
SW1	Logic-Low

**Power On/Off Sequence**

The Power On Sequence is :

While EN134 goes high, CH1 will be turned on to wait for the completion of CH1's soft-start. After that, CH3 will be turned on to wait for the completion of CH3's soft-start. And then, CH4 will be turned on to wait for the completion of CH4's soft-start. Then, SW1 will be turn on and CH2 is allowed to be turn on by EN2 at any time. Finally, SW1 soft-start will be completed.

The Power-Off Sequence is :

At first, while EN134 goes low, (SW1 is shutdown and internally pull low, CH2 must be turned off by EN2) SW1

and CH2 (Note A) will be shutdown. After that, CH4 will be turned off and internally pulled low to wait for the completion of CH4's shutdown. And then, CH3 will be turned off and internally pulled low to wait for CH3's shutdown completion. Then, CH1 will be turned off and internally pulled low (Note B) to wait for CH1's shutdown completion. Finally, the whole IC will be shutdown (if EN2, EN5, EN6 and EN7 already go low).

Note A : If CH2 is configured as a step -up, then the CH2 will not be internally pulled low and the completion of shutdown will not be checked.

Note B : CH1 is configured as a step -up, so the CH1 will not be internally pulled low and the completion of shutdown will not be checked.

**Table 4. Power On/Off Sequence**

Power On Sequence	CH1 -> CH3 -> CH4 -> (SW1 and CH2)
Power Off Sequence	(SW1 and CH2) -> CH4 -> CH3 -> CH1

**Thermal Considerations**

For continuous operation, do not exceed absolute maximum operation junction temperature. The maximum power dissipation depends on the thermal resistance of IC package, PCB layout, the rate of surroundings airflow and temperature difference between junction to ambient. The maximum power dissipation can be calculated by following formula :

$$P_{D(MAX)} = (T_{J(MAX)} - T_A) / \theta_{JA}$$

Where  $T_{J(MAX)}$  is the maximum operation junction temperature,  $T_A$  is the ambient temperature and the  $\theta_{JA}$  is the junction to ambient thermal resistance.

For recommended operating conditions specification of RT9971, The maximum junction temperature is 125°C. The junction to ambient thermal resistance  $\theta_{JA}$  is layout dependent. For WQFN-40L 5x5 packages, the thermal resistance  $\theta_{JA}$  is 36°C/W on the standard JEDEC 51-7 four layers thermal test board. The maximum power dissipation at  $T_A = 25^\circ\text{C}$  can be calculated by following formula :

$$P_{D(MAX)} = (125^\circ\text{C} - 25^\circ\text{C}) / (36^\circ\text{C}/\text{W}) = 2.778\text{W for WQFN-40L 5x5 packages}$$

The maximum power dissipation depends on operating ambient temperature for fixed  $T_{J(MAX)}$  and thermal resistance  $\theta_{JA}$ . For RT9971 packages, the Figure 1 of derating curves allows the designer to see the effect of rising ambient temperature on the maximum power allowed.

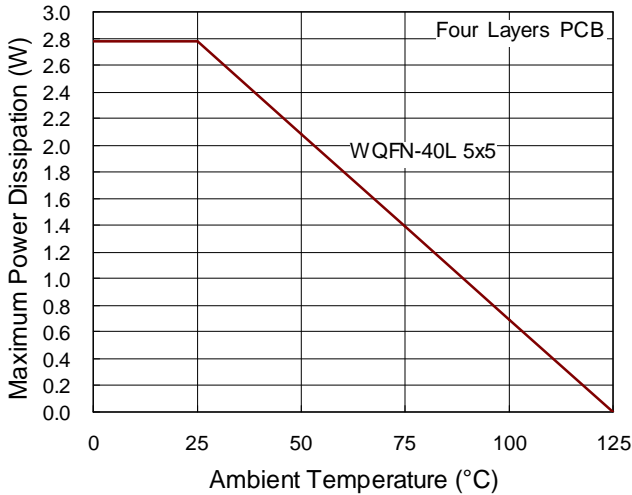

Figure 1. Derating Curves for RT9971 Packages

## Layout Considerations

For the best performance of the RT9971, the following PCB layout guidelines must be strictly followed.

- } Place the input and output capacitors as close as possible to the input and output pins respectively for good filtering.
- } Keep the main power traces as wide and short as possible.
- } The switching node area connected to LX and inductor should be minimized for lower EMI.
- } Place the feedback components as close as possible to the FB pin and keep these components away from the noisy devices.
- } Place the compensative components as close as possible to the COMP pin and keep these components away from the noisy devices.
- } Connect the GND and Exposed Pad to a strong ground plane for maximum thermal dissipation and noise protection.

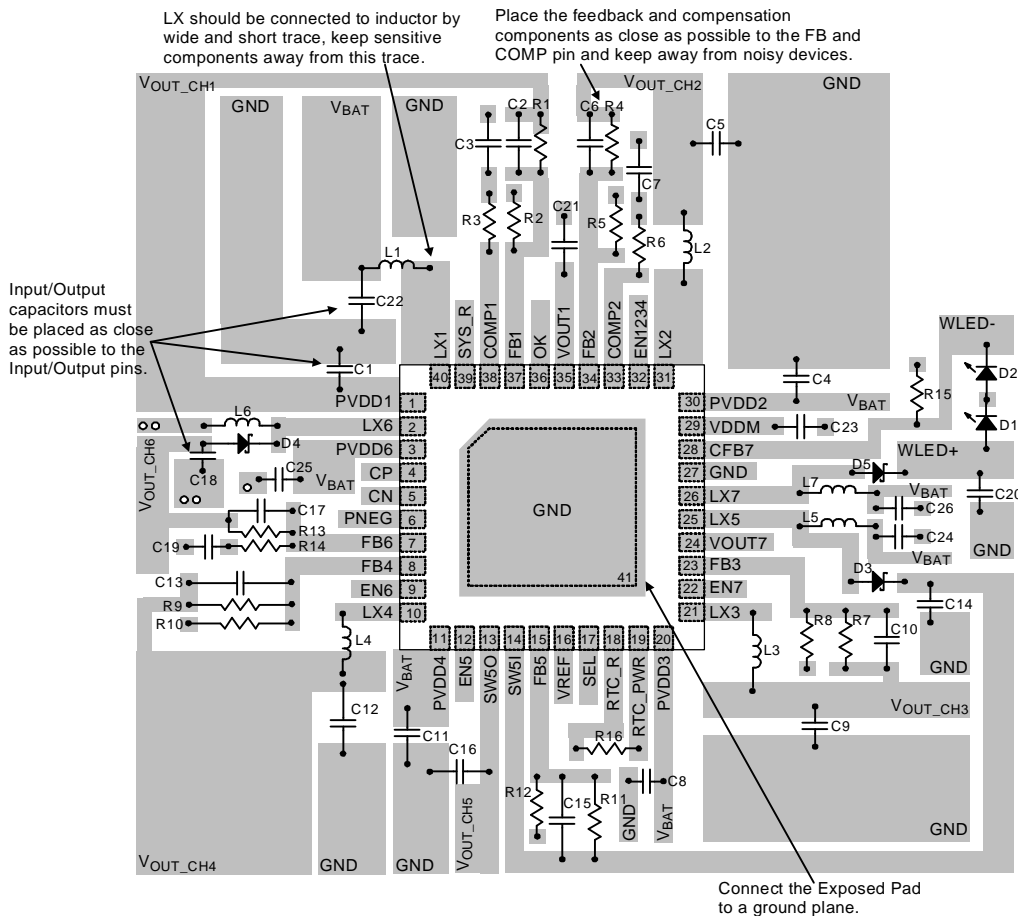
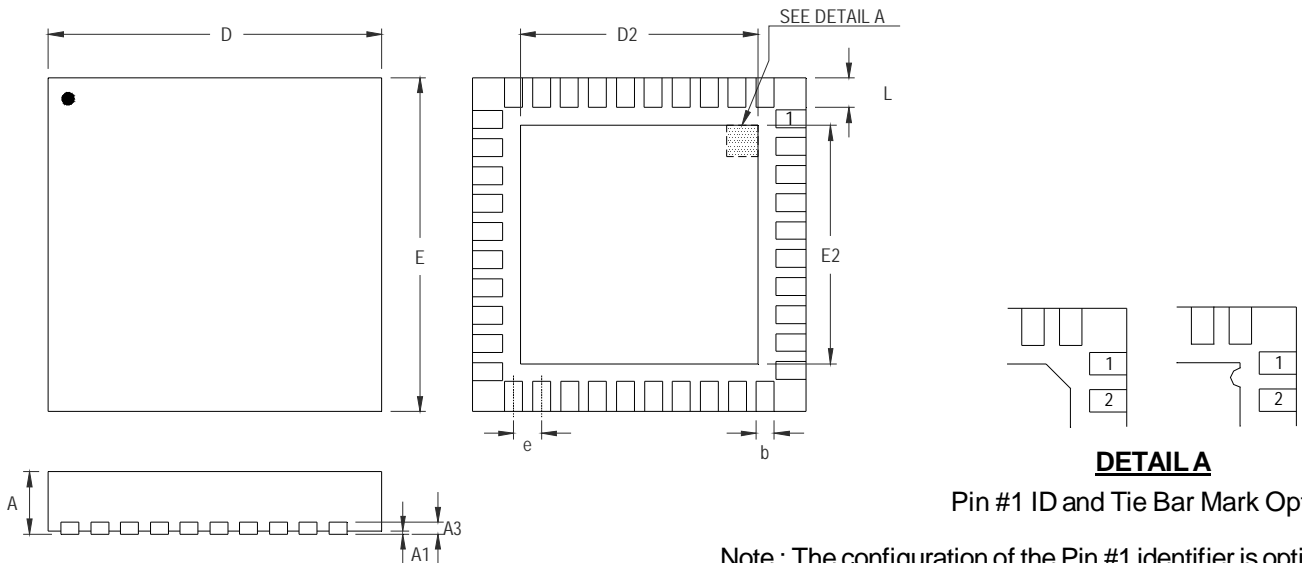

Figure 2. PCB Layout Guide

**Table 5. Protection Items**

	Protection type	Threshold (typical) Refer to Electrical spec.	Protection methods	IC Shutdown Delay time	Reset method
V <sub>DDM</sub>	OVP	V <sub>DDM</sub> > 6.25V	Automatic reset at V <sub>DDM</sub> < 6V	100ms	V <sub>DDM</sub> power reset
CH1 Step-Up	Current Limit	N-MOSFET current > 3A	N-MOSFET off, P-MOSFET off. Automatic reset at next clock cycle	100ms	V <sub>DDM</sub> power reset
	PVDD1 OVP	PVDD1 > 6.25V	N-MOSFET off, P-MOSFET off.	No-delay	V <sub>DDM</sub> power reset
CH2 Step-Up	Current Limit	N-MOSFET current > 3A	N-MOSFET off, P-MOSFET off. Automatic reset at next clock cycle	100ms	V <sub>DDM</sub> power reset
	PVDD2 OVP	PVDD2 > 6.25V	N-MOSFET off, P-MOSFET off.	No-delay	V <sub>DDM</sub> power reset
CH2 Step-Down	Current Limit	P-MOSFET current > 1.5A	N-MOSFET off, P-MOSFET off. Automatic reset at next clock cycle	100ms	V <sub>DDM</sub> power reset
CH3 Step-Down	Current Limit	P-MOSFET current > 1.5A	N-MOSFET off, P-MOSFET off. Automatic reset at next clock cycle	100ms	V <sub>DDM</sub> power reset
CH4 Step-Down	Current Limit	P-MOSFET current > 1.5A	N-MOSFET off, P-MOSFET off. Automatic reset at next clock cycle	100ms	V <sub>DDM</sub> power reset
CH5 Asyn Step-Up	Current Limit	N-MOSFET current > 1.2A	N-MOSFET off. Automatic reset at next clock cycle	100ms	V <sub>DDM</sub> power reset
CH6 Inverting	Current Limit	P-MOSFET current > 1.5A	P-MOSFET off. Automatic reset at next clock cycle	100ms	V <sub>DDM</sub> power reset
CH7 WLED	Current Limit	N-MOSFET current > 0.8A	N-MOSFET off. Automatic reset at next clock cycle	Not Applicable	Automatic reset at next clock cycle
	OVP	V <sub>OUT7</sub> > 14V	Shutdown CH7	Not Applicable	Reset by toggling EN7
SW 1	UVP	V <sub>OUT1</sub> < 1.75V after SW1 soft start end	Automatic reset at V <sub>OUT1</sub> > 1.75V	100ms	V <sub>DDM</sub> power reset
SW 5	OVP	SW5I > 18V	N-MOSFET off	No-delay	V <sub>DDM</sub> power reset
	UVP	SW5O < 0.4V after SW5 soft start end	Automatic reset at SW5O > 0.4V	100ms	V <sub>DDM</sub> power reset
Thermal	Thermal shutdown	Temperature > 160°C	All channels stop switching	No-delay	Temperature < 140°C
CH2 Step-Down	UVP	FB2 < 0.4V after CH2 soft start end	N-MOSFET off, P-MOSFET off. Automatic reset at FB2 > 0.4V	100ms	V <sub>DDM</sub> power reset
CH3 Step-Down	UVP	FB3 < 0.4V after CH3 soft start end	N-MOSFET off, P-MOSFET off. Automatic reset at FB3 > 0.4V	100ms	V <sub>DDM</sub> power reset
CH4 Step-Down	UVP	FB4 < 0.4V after CH4 soft start end	N-MOSFET off, P-MOSFET off. Automatic reset at FB4 > 0.4V	100ms	V <sub>DDM</sub> power reset
CH5	UVP	FB5 < 0.8V after CH5 soft start end	N-MOSFET off.	No-delay	V <sub>DDM</sub> power reset
CH6	UVP	FB6 > 0.4V	P-MOSFET off.	No-delay	V <sub>DDM</sub> power reset

Outline Dimension



**DETAIL A**  
Pin #1 ID and Tie Bar Mark Options

Note : The configuration of the Pin #1 identifier is optional, but must be located within the zone indicated.

Symbol	Dimensions In Millimeters		Dimensions In Inches	
	Min	Max	Min	Max
A	0.700	0.800	0.028	0.031
A1	0.000	0.050	0.000	0.002
A3	0.175	0.250	0.007	0.010
b	0.150	0.250	0.006	0.010
D	4.950	5.050	0.195	0.199
D2	3.250	3.500	0.128	0.138
E	4.950	5.050	0.195	0.199
E2	3.250	3.500	0.128	0.138
e	0.400		0.016	
L	0.350	0.450	0.014	0.018

W-Type 40L QFN 5x5 Package

**Richtek Technology Corporation**

Headquarter  
5F, No. 20, Taiyuen Street, Chupei City  
Hsinchu, Taiwan, R.O.C.  
Tel: (8863)5526789 Fax: (8863)5526611

**Richtek Technology Corporation**

Taipei Office (Marketing)  
5F, No. 95, Minchiuan Road, Hsintien City  
Taipei County, Taiwan, R.O.C.  
Tel: (8862)86672399 Fax: (8862)86672377  
Email: marketing@richtek.com

Information that is provided by Richtek Technology Corporation is believed to be accurate and reliable. Richtek reserves the right to make any change in circuit design, specification or other related things if necessary without notice at any time. No third party intellectual property infringement of the applications should be guaranteed by users when integrating Richtek products into any application. No legal responsibility for any said applications is assumed by Richtek.